



**INSTITUTO DE CIENCIAS  
DE LA CONSTRUCCIÓN  
EDUARDO TORROJA**

*C/ Serrano Galvache n. 4. 28033 Madrid (Spain)  
Tel.: (34) 91 302 04 40 / Fax: (34) 91 302 07 00  
[direccion.ietcc@csic.es](mailto:direccion.ietcc@csic.es) [www.ietcc.csic.es](http://www.ietcc.csic.es)*



## European Technical Assessment

**ETA 06/ 0058  
of 02/ 02/ 2017**

English translation prepared by IETcc. Original version in Spanish language

### General Part

**Technical Assessment Body issuing the ETA and designated according to Article 29 of the Regulation (EU) Nº305/2011:**

Instituto de Ciencias de la Construcción Eduardo Torroja (IETcc)

**Trade name of the construction product**

**POLYDAN PLUS FM**

**Product family to which the construction product belongs**

Systems of mechanically fastened flexible SBS roof waterproofing membranes.

**Manufacturer**

DERIVADOS ASFALTICOS NORMALIZADOS (DANOSA), S.A  
c/ La Granja nº 3. 28108 ALCOBENDAS  
MADRID, Spain

**Manufacturing plant(s)**

Sector 9, Polígono Industrial. 19290. FONTANAR  
GUADALAJARA, Spain

**This European Technical Assessment contains**

14 pages including 2 Annexes which form an integral part of this assessment.  
Annex 3. Contain confidential information and is not included in the ETA when that assessment is publicly available

**This European Technical Assessment is issued in accordance with regulation (EU) No 305/2011, on the basis of**

Guideline for European Technical Approval (ETAG) nº 006, used as European Assessment Document (EAD)

**This version replaces**

ETA 06/0058 issued on 05/ 05/ 2016

Translations of this European Technical Assessment in other languages shall fully correspond to the original issued document and should be identified as such.

Communication of this European Technical Assessment, including transmission by electronic means, shall be in full (excepted the confidential Annex(es) referred to above). However, partial reproduction may be made, with the written consent of the issuing Technical Assessment Body. Any partial reproduction has to be identified as such.

This European Technical Assessment may be withdrawn by the issuing Technical Assessment Body, in particular pursuant to information by the Commission according to Article 25 Paragraph 3 of Regulation (EU) No 305/2011.

## SPECIFIC PARTS OF THE EUROPEAN TECHNICAL ASSESSMENT

### 1 Technical description of the product

POLYDAN PLUS FM is a single-ply flexible (SBS) waterproofing roof Kit fastened mechanically with metallic point fasteners in area of overlapping at edge of roofing with a slope exceeding 1%. This Kit is constituted by bitumen membranes manufactured by the applicant of this ETA and metallic fastener manufactured by other manufacturers:

**Main membrane:** POLYDAN PLUS FM 50/GP ELAST, POLYDAN PLUS FM 180-60/GP ELAST, POLYDAN PLUS FM 180-60/GP FRBR ELAST and POLYDAN PLUS FM 50/GP FRBR ELAST.

**Auxiliary membranes:** (these membranes are used in singular details): ESTERDAN FM 30 P ELAST, REINFORCEMENT STRIP E 30 P ELAST (0,32), ESTERDAN EQUERRE 25, ESTERDAN PLUS 40/GP ELAST, ESTERDAN PLUS 50/GP ELAST, POLYDAN 180- 50/GP ELAST POLYDAN PLUS FM 50/GP ELAST, POLYDAN PLUS FM 180-60/GP ELAST, POLYDAN PLUS FM 180-60/GP FRBR ELAST and POLYDAN PLUS FM 50/GP FRBR ELAST.

**Fasteners EVDF/ZBJ 2C or 3C with 40 x 40 mm DF -washers** by L.R. ETANCO (Annex 1) are used for steel deck. Other fasteners are possible if these have the same or higher performance characteristics than the fasteners indicated above. For these fasteners verification according to 5.1.4.1 and Annex C of ETAG 006 is necessary. The annex 2 includes a list of fasteners for different kinds of supports, which comply with the requirements of this ETA.

The kit supplier is also responsible that only fasteners are used which fulfil the requirements of the AoC procedure. The assessment of this Kit does not include the thermal insulation. The thermal insulation often used with this kit are Panel of mineral wool, of Polyisocyanurate, of polyurethane or of cellulose. The supports often used with this kit are: Corrugated steel plates, corrugated steel of punched or bursted surface, Concrete, Aerated concrete, Wood and wooden boards.

### 2 Specification of the intended use in accordance with the applicable EAD

The intended use of this product is the waterproofing of roofs with slopes exceeding 1%, preventing the passage of water pass into the interior of the building, both in liquid or vapour form. This assembled system complies with Essential Requirements 2, 3 and 4: Safety in the case of fire, Hygiene, health and environment, and Safety in use, of directive 89/106/EEC.

The provisions made in this ETA are based on an assumed intended working life of the assembled system at least of 10 years. The indication given on the assumed intended working life cannot be interpreted as a guarantee given by the manufacturer, but are only to be regarded as a means for choosing the right products in relation to the expected economically reasonable working life of the works.

"Assumed intended working life" means that, when an assessment following the ETAG provisions is made, and when this working life has elapsed, the real working life may be, in normal use conditions, considerably longer without major degradation affecting the Essential Requirements.

**Installation.** The fitness for use of this POLYDAN PLUS FM system can only be assumed if installation is carried out according to the manufacturer's instructions. It is the responsibility of the manufacturer to guarantee that the information on the application of its products is correctly given to the users. Particularly, it is recommended to consider:

Overlap. The longitudinal and transversal overlap between membranes must always be  $12 \pm 1$  cm.

Fasteners. Mechanical fastening of the Systems is carried out on the overlaps, using the aforementioned fasteners, and the washers must be applied at a distance between 2-3 cm from the edge of the membrane, as indicated in figure 1. Minimum distance between fasteners must be 18 cm, and maximum 36 cm. Maximum distance between rows of fasteners is  $88 \pm 1$  cm.

The number of fasteners per square metre is determined by the varying air pressure on the roof, which depends on the geographic area, area of the roof and height of the building. For the number of fasteners/m<sup>2</sup> the wind uplift resistance of the fastener and the national regulations and administrative provisions of the member state of destination shall be taken into account.

Intersection at protruding elements. At the intersections with protruding elements (duct for utility installations, etc.) the waterproofing is finished off on a smooth metal profile. This support/profile is anchored mechanically to the fretwork sheet, installed to remain independent of the duct element, which is mechanically fastened to the support deck (fig. 2).

Structural joint. Prior to installation of the membrane and insulation, the structural joint formation profiles must be made available according to the drawing (fig. 2), i.e. plate anchored on one side (flat metal sheet) over the sheet as carrier of the joint insulation, anchoring of the joint formation base profiles (the separation of which will depend on foreseen movement) and insulation of the joint centre, which must be installed prior to closing the second profile.

As reinforcement strip are used ESTERDAN FM 30 P ELAST membranes (cut to the necessary dimensions) or the strips BANDA DE REFUERZO E 30 P ELAST (0,32) or ESTERDAN EQUERRE 25.

As finished membrane is used POLYDAN PLUS FM 50/GP ELAST, POLYDAN PLUS FM 180-60/GP ELAST, ESTERDAN PLUS 40/GP ELAST, ESTERDAN PLUS 50/GP ELAST, POLYDAN 180-50/GP ELAST, POLYDAN PLUS FM 180-60/GP FRBR ELAST and POLYDAN PLUS FM 50/GP FRBR ELAST membranes cut to the necessary dimensions.

Intersection at vertical facing. Intersection at vertical facings is carried out by following the drawing in figure 3.

Gutter catch basins. The final waterproof is preformed with ESTERDAN FM 30 P ELAST and a finish membrane of POLYDAN PLUS FM 50/GP ELAST or POLYDAN PLUS FM 180-60/GP ELAST or POLYDAN PLUS FM 180-60/GP FRBR ELAST or POLYDAN PLUS FM 50/GP FRBR ELAST (fig.4). In this case, it will ensure the compatibility of the gutter catch basins with the waterproof membranes.

Reinforced areas. In areas with side angles (corners), in the event a greater number of fasteners is required, a reinforcing membrane ESTERDAN FM 30 P ELAST will have to be installed throughout the area, which will allow us to apply one or more rows of fasteners. The new row of fasteners must be situated in the central area of the upper membrane (fig. 5). The main membrane will be welded on the reinforcing membrane

Valley gutters. This application is carried out using a two-ply system, by applying a reinforcement membrane anchored to the ESTERDAN FM 30 P ELAST carrier, according to figure 6 and with the number of fasteners that correspond to the area of the roof; the POLYDAN PLUS FM 50/GP, POLYDAN PLUS FM 180-60/GP ELAST or POLYDAN PLUS FM 180-60/GP FRBR ELAST or POLYDAN PLUS FM 50/GP FRBR ELAST membrane are adhered to this membrane (fig. 5).

Traffic areas. The traffic areas will be correctly protected (light tiles, etc..) to avoid damages in the waterproof membrane.

**Use, maintenance and repair of the works.** Assessment of the fitness for use is based on the assumption that periodical maintenance of the roof is carried out. Maintenance must include:

- Inspection of the roof at regular intervals.
- Cleaning of downpipes and filters.
- Removal of stones, branches and leaves, etc.
- Inspection of flashing along the edges of the roof, chimneys, drains, skylights, etc.

If the Waterproofing System has been damaged, and is causing leakage, qualified installers must repair it immediately. Maintenance, preservation or remedial work personnel must wear footwear with a suitable sole. Further details are laid down in the MTD located at IETcc.

### **3 Performance of the product and references to the methods used for its assessment**

Assessment of the fitness of the POLYDAN PLUS FM Kit for the intended use, with regard to Essential Requirements 2, 3 and 4, was performed in compliance with the "Guideline of Systems of mechanically fastened flexible roof waterproofing membranes" (ETAG 006).

The characteristics of this Kit show values, which are within the requirements and tolerances established in the Manufacturer's Technical Dossier (MTD), and which are shown below. This assessment could be extended with other requirements applicable to dangerous substances resulting from transposed European legislation or national regulations and administrative provisions. Moreover, this assessment could be extended with other requirements applicable to the products, resulting from the application of other national regulations and administrative provisions.

### 3.1 Characteristics of the Kit

#### Safety in the case of fire (BWR 2)

##### External fire performance.

Classification	System
Broof(t1)	The systems installed on non-combustible support (A1-A2) enclosed in point 1 with slope roof < 20°.
Broof(t2)	Membrane POLYDAN 180-50/GP FRBR ELAST, installed on combustible or non-combustible support having a density greater than or equal to 472,5 kg/m <sup>2</sup> with all pitches
Broof(t3)	Membrane POLYDAN PLUS FM 180-60/GP FRBR ELAST, applied in any steel deck (non-perforated) and in any continuous support thicker than 10mm, with a thermal insulation having a density greater than or equal to 110 kg/m <sup>2</sup> with a slope roof <10°.

#### Hygiene, health and environment (BWR 3)

**Release of dangerous substances.** According to the manufacture's statement, the product does not contain any dangerous substance according to the EU database.

#### Safety in use (BWR 4)

**Wind uplift resistance.** The Kit tested is the constituted by the main membrane, Mineral POLYDAN PLUS FM 50/GP ELAST and the fasteners indicated in point 1. Wadm = 528 N/fastener.

### 3.2 Membrane Performance

Safety in case of fire (BWR 2). **Reaction to fire.** Euroclass E, according to EN 13501.

#### Hygiene, health and environment (BWR 3)

Performance	Units	Standard	Values
Resistance Peel resistance of joints	Maximum (N/50 mm) (L/T)	EN 12316-1	185 / 172
	Average (N/50 mm) (L/T)		145 / 130
R. Shear resistance of joints	N/50 mm (L/T)	EN 12317-1	585 /733
R. Tear resistance (nail)	N (L/T)	EN 12310-1	308 /264
Low temperature bending/folding	T°C	EN 1109	-20
Watertightness	----	EN 1928	Watertight
Water vapour permeability	μ	EN 1931	20.000
Tensile properties	Tensile strength (N/5cm) (L/T)	EN 12311-1	903 / 684
	Elongation (%) (L/T)		49/51
Static loading resistance	kg	EN 12730	20
Dynamic loading resistance	mm	EN 12691	2000

#### Safety in use (BWR 4)

**Slipperiness.** In accordance with item 5.2.4.1 of EOTA 006 Guideline, the bituminous membranes comply satisfactorily with this characteristic and it is not necessary to run the test.

#### Aspects related to durability and serviceability

**Hot water Resistance (EN 1847).** The samples are immersed in water during 30 days at 60 ± 2°C, after which the following tests are carried out:

Performance	Direction	Values
Peel resistance (N/50mm)	Longitudinal // Transversal	205 / 160 (Max/med) 229 / 165 (Max/med)
Shear resistance (N/50mm)	Longitudinal/ Transversal	635 / 642

The results obtained show acceptable behaviour of the membranes, the decrease in peel and shear resistances being less than 20%.

**Heat exposure resistance (EN 1296).** The samples are exposed to a temperature of 70 ± 2°C during 168 days, after which the following tests are carried out:

Performance	Direction	Values
Peel resistance (N/50mm)	Longitudinal	159/120 (Max/med)
	Transversal	145/110 (Max/med)
Tear resistance	It is not necessary to run the test as the membranes in the Kit are reinforced	
Shear resistance (N/50mm)	Longitudinal	670
	Transversal	720
Low temperature bending/folding (°C)	Upper face	- 10
	Down face	- 10

The results obtained show acceptable behaviour of the membranes, as the decrease in peel and shear resistance is less than 20% and the decrease in the resistance to cold bending/folding is below 15°C.

**Resistance to UV-radiation in the presence of moisture.** In accordance with the EOTA 006 Guideline, it is not necessary to perform this test, as adherence of the mineral granule protection is higher than 70% (EN 12039).

**Dimensional stability** (EN 1107). - 0.2 %. Results obtained show acceptable behaviour of the membrane, as its dimensional stability is less than 0.6%.

### 3.3 Performances of mechanical fasteners

#### Safety in use (BWR4)

**Axial load** (ETAG 006, 5.3.4.1). According to the ETA 08/0239 of the fastener with the fastener, the value is 1640N.

**Unwinding resistance.** Apt, according to ETA 08/0239

#### Aspects related to durability, serviceability and identification

**Resistance to corrosion.** The screws and washers show good corrosion resistance (ETA 08/0239).

### 3.4 Identification of components

#### Main membrane

**POLYDAN PLUS FM 50/GP ELAST.** SBS modified bitumen waterproofing membrane of 5 Kg/m<sup>2</sup> with a mineral finish and 190 g/m<sup>2</sup> reinforcement made up of a non-woven polyester felt mesh (FM) reinforced and stabilized with the insertion of a glass fibre mesh.

**POLYDAN PLUS FM 180-60/GP ELAST.** SBS modified bitumen waterproofing membrane of 5,6 Kg/m<sup>2</sup> with a mineral finish and 190 g/m<sup>2</sup> reinforcement made up of a non-woven polyester felt mesh (FM) reinforced and stabilized with the insertion of a glass fibre mesh

**POLYDAN PLUS FM 180-60/GP FRBR ELAST.** SBS modified bitumen (with fire retardant treatment) waterproofing membrane of 5,6 Kg/m<sup>2</sup> with a mineral finish and 190 g/m<sup>2</sup> reinforcement made up of a non-woven polyester felt mesh (FM) reinforced and stabilized with the insertion of a glass fibre mesh.

**POLYDAN PLUS FM 50/GP FRBR ELAST.** SBS modified bitumen (with fire retardant treatment) waterproofing membrane of 5 Kg/m<sup>2</sup> with a mineral finish and 190 g/m<sup>2</sup> reinforcement made up of a non-woven polyester felt mesh (FM) reinforced and stabilized with the insertion of a glass fibre mesh.

The main characteristics of these membranes are:

Characteristics	POLYDAN PLUS FM 50/GP E	POLYDAN PLUS FM 50/GP FRBR E	POLYDAN PLUS FM 180/60/GP E	POLYDAN PLUS FM 180/60/GP FRBR E
Reinforcement (g/m <sup>2</sup> )	Composite: Polyester felt/glass fibre reinforcement 190 (± 15%)			
Weight (g/m <sup>2</sup> )	4800 - 5500		5300-6100	
Bitumen compound (g/m <sup>2</sup> )	3900 (± 10%)		4500 (± 10%)	
Protection film (g/m <sup>2</sup> )	< 14		≤ 14	
Mineral finish (g/m <sup>2</sup> )	> 900 (average 1100)		≥ 900 (medium value 1100)	
Nominal thickness (mm)	4,1 (±10%) // Overlap 3,5 (±10%)		4,6 (±10%) // Overlap 4,0 (±10%)	
Roll dimensions (8 m x 1m)	> 8		≥ 8	
Roll weight (kg)	38 - 45		42 - 49	
Overlap width (mm)	110-130		110-130	

#### **Auxiliary membranes.**

**ESTERDAN FM 30 P ELAST.** 3 Kg/m<sup>2</sup> SBS bitumen-modified reinforcement membrane, with 160 g/m<sup>2</sup> non-woven polyester felt reinforcement.

**BANDA DE REUFERZO E 30 P (0,32):** Reinforcement strip of 3 Kg/m<sup>2</sup> SBS bitumen-modified reinforcement membrane, with 140 g/m<sup>2</sup> non-woven polyester felt reinforcement with a width of 32 cm

**ESTERDAN EQUERRE 25:** Reinforcement strip of 4 Kg/m<sup>2</sup> SBS bitumen-modified reinforcement membrane, with 140 g/m<sup>2</sup> non-woven polyester felt reinforcement with a width of 25 cm

ESTERDAN PLUS 40/GP ELAST: 4 Kg/m<sup>2</sup> SBS bitumen-modified reinforcement membrane, with 150 g/m<sup>2</sup> polyester felt reinforcement with granulated mineral coat finished.

ESTERDAN PLUS 50/GP ELAST.: 5 Kg/m<sup>2</sup> SBS bitumen-modified reinforcement membrane, with 150 g/m<sup>2</sup> polyester felt reinforcement and stabilized with granulated mineral coat finished.

POLYDAN 180-50/GP ELAST.: 5 Kg/m<sup>2</sup> SBS bitumen-modified reinforcement membrane, with 180 g/m<sup>2</sup> non-woven polyester felt with granulated mineral coat finished.

POLYDAN PLUS FM 50/GP ELAST.

POLYDAN PLUS FM 180-60/GP ELAST.

POLYDAN PLUS FM 180-60/GP FRBR ELAST.

POLYDAN PLUS FM 50/GP FRBR ELAST.

The main characteristics of these membranes are:

Characteristics	ESTERDAN FM 30 P ELAST	BANDA DE REFUERZO E 30 P (0,32)	ESTERDAN EQUERRE 25	ESTERDAN PLUS 40/GP ELAST	ESTERDAN PLUS 50/GP ELAST	PPLYDAN 180-50/GP ELAST
Reinforcement (g/m <sup>2</sup> )	Polyester reinforced 160 (± 15%)	Polyester felt 140 (± 15%)		Polyester felt/ reinforcement glass fiber.		Polyester felt. 180 (± 15%)
				140 (± 15%)	160 (± 15%)	
Weight (g/m <sup>2</sup> )	2800 - 3200		3800 - 4200		4800 - 5500	
Bitumen compoundg/m <sup>2</sup>	2900 (± 10%)		3900 (± 10%)	2900 (± 10%)	3900 (± 10%)	
Protection film (g/m <sup>2</sup> )	< 24			< 14		
Mineral finish (g/m <sup>2</sup> )	--	--	--	> 900 (average 1100)		
Nominal thickness (mm)	2.4 (± 10 %)	2.4 (± 10 %)	3.4 (± 10 %)	3.1 (± 10 %)	4.1 (± 10 %)	4.1 (± 10 %)
Roll dimensions	12 x 1 m	12 x 0,32m	10 x 0,25m	8 x 1	8 x 1	8 x 1
Roll weight (kg)	34 - 39	---	----	28 - 35	38 - 45	38 - 45
Overlap width (mm)	--	--	--	70-90	70-90	70-90
Intended use	Inferior Reinforcement (If required)	Inferior Reinforcement in emergent elements		Finishing reinforcement in emergent elements		

#### Fasteners.

EVDF/ZBJ 2C screw. Double-thread, self-drilling screw, with a diameter of 4.8 mm, lengths of 65-75-90-110-140 mm and with a 12-mm diameter flat head. Supracoat 2C-treated zinc-coated steel, with a corrosion resistance of 15 Kesternich cycles.

40 x 40-mm DF washer, with a thickness of 8/10 mm and with a 4,8-mm diameter hole, made of Z 275 galvanized steel with protective 2C treatment.

#### 4. Assessment and verification of constancy of performance (AVCP) system applied, with reference to its legal base

**System of Attestation of Conformity.** The European Commission according to the decision (98/143/EC of February 1998, Official Journal of the European Communities No. L 42, 14.02.1998) on the Procedures of Attestation of Conformity (Annex III, clause 2(ii) first possibility of EU Regulation 305/2011) for Systems of mechanically fastened flexible roof waterproofing membranes.

Product	Intended uses	Level or Classes	System
POLYDAN PLUS FM	Systems of mechanically fastened flexible SBS roof waterproofing membranes	Any	+2

According to this decision, system +2 establishes: *Tasks of the manufacturer:* Factory production control and Initial type-testing of the product and *Tasks of the notified body:* Initial inspection of the factory and production control and Continuous surveillance, assessment and approval of factory production control.

#### 5 Technical details necessary for the implementation of the AVCP system, as provided for the applicable EAD

The ETA is issued for this kit on the basis of agreed data/information, deposited at IETcc, which identifies the product that has been assessed and judged. It is the manufacturer's responsibility to make sure that all those who use the kit are appropriately informed of specific conditions according to sections 1, 2, 4 and 5 including the annexes of this ETA. Changes to the membrane or the components or their production

process, which could result in this deposited data/information being incorrect should be notified to the IETcc before the changes are introduced. IETcc will decide whether or not such changes affect the ETA and if so whether further assessment or alterations to the ETA shall be necessary.

## 5.1 Tasks of the manufacturer

**Factory production control.** The manufacturer shall exercise permanent internal control of production and ensure that the results obtained comply with the quality level required. All the elements, requirements and provisions adopted by the manufacturer are documented in a systematic manner in the form of written procedures and regulations. This control production system documentation ensures a common understanding of quality assurance and enables the achievement of the required product characteristics according to the ETA.

The manufacturer may only use components stated in the technical documentation of this ETA including Control Plan. The incoming raw materials are subjected to verifications by the manufacturer before acceptance.

The factory production control shall be in accordance with the Control Plan<sup>(1)</sup> which is part of the Technical Documentation of this ETA. The Control Plan has been agreed between the manufacturer and the IETcc and is laid down in the context of the factory production control system operated by the manufacturer and deposited at the IETcc. The results of factory production control shall be recorded and evaluated in accordance with the provisions of the Control Plan.

**Initial type-testing of the product.** Initial type-testing carried out by the IETcc is that set out in chapter 5 of the guideline for Systems of mechanically fastened flexible roof waterproofing membranes (ETAG 006). The IETcc assessed the results of these tests in accordance with chapter 6 of this Guide, as part of the ETA issuing procedure.

The verifications underlying this ETA have been furnished on samples from the current production, these will replace the initial type-testing carried. After changing the production process or starting the production in another manufacturing plant the initial type-test shall be repeated.

**Other tasks of the manufacturer. Other tasks of manufacturer.** The manufacturer shall, on the basis of a contract, involve a body which is notified for the tasks referred to in section 4 in order to undertake the actions laid down in this clause. For this purpose, the control plan shall be handed over by the manufacturer to the notified bodies involved.

For initial type – testing, the results of the tests performed as part of the assessment for the ETA shall be used unless there are changes in the production line or plant. In such cases the necessary initial type- testing has to be agreed with the IETcc.

The manufacturer shall make a declaration of conformity, stating that the construction product is in conformity with the provisions of this ETA

## 5.2 Tasks of the Notified body

**Initial inspection of factory and production control.** The notified body ascertains that, in accordance with the MTD, factory conditions and production control allow the manufacturer to ensure the consistency and homogeneity of the manufactured product and its traceability, thus guaranteeing that the final characteristics of the product are those indicated in point 2.

**Continuous surveillance, assessment and approval of Factory Production Control.** The Notified body shall visit the factory at least twice a year. Surveillance of the manufacturing process shall include:

- Checking the documentation of factory production control, to ensure continuing compliance with the provisions of the ETA,
- Identification of changes by comparing data obtained during the initial inspection or during the last inspection.

In the event the ETA provisions are not complied with, the certificate of conformity shall be withdrawn.

---

<sup>(1)</sup> The control plan is a confidential part of this European Technical Assessment and only handed over to the notified body involved in the procedure of attestation of conformity.



Issued in Madrid on 02 February 2017  
by



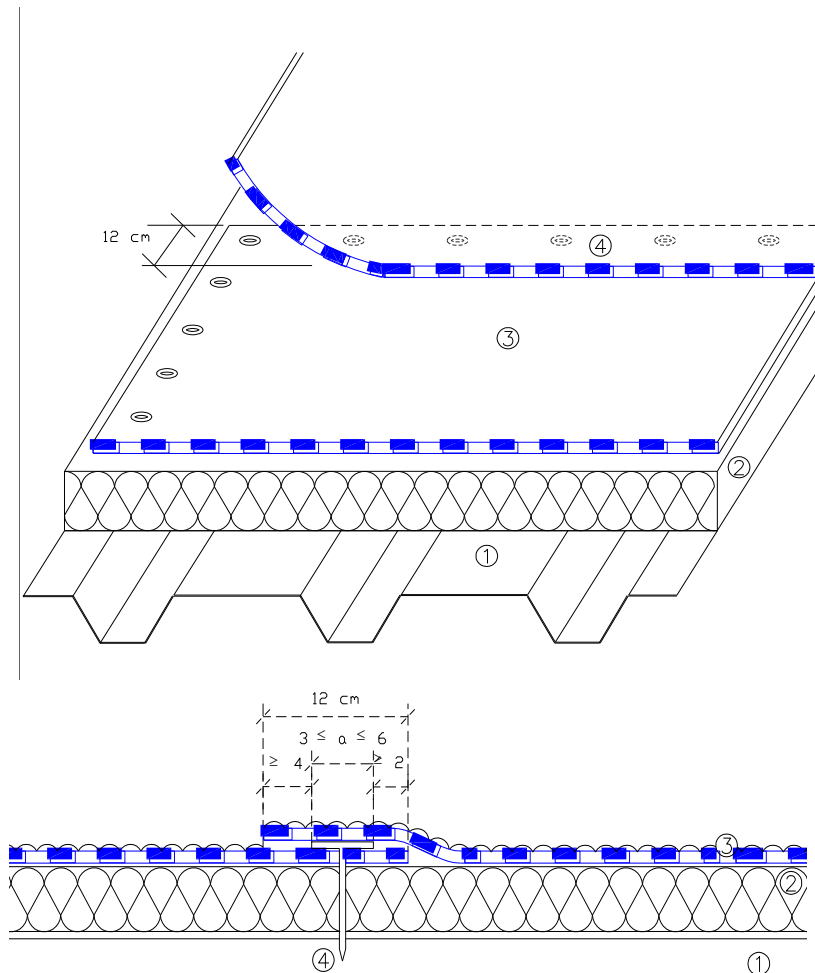
Instituto de Ciencias de la Construcción Eduardo Torroja  
**CONSEJO SUPERIOR DE INVESTIGACIONES CIENTÍFICAS**  
c/ Serrano Galvache 4. 28033 Madrid (Spain).  
director.ietcc@csic.es www.ietcc.csic.es



On behalf of the Instituto de Ciencias de la Construcción Eduardo Torroja

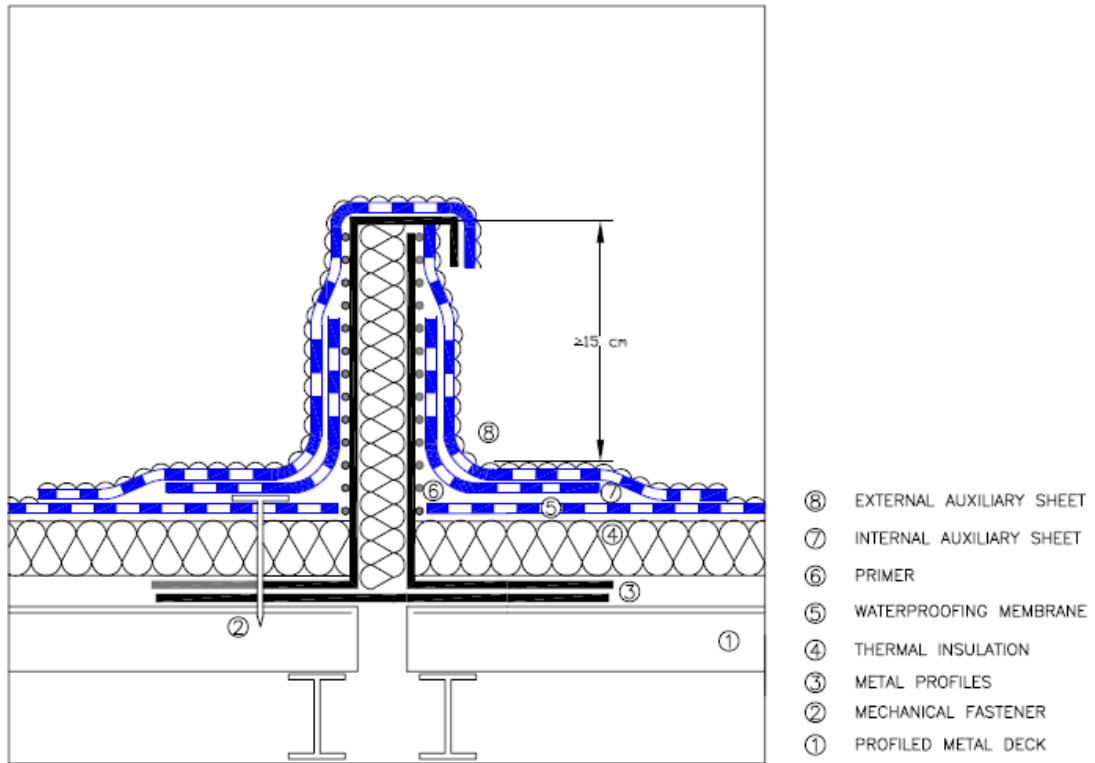
Marta Mº Castellote  
Director

### 1 Detail of membrane overlap.

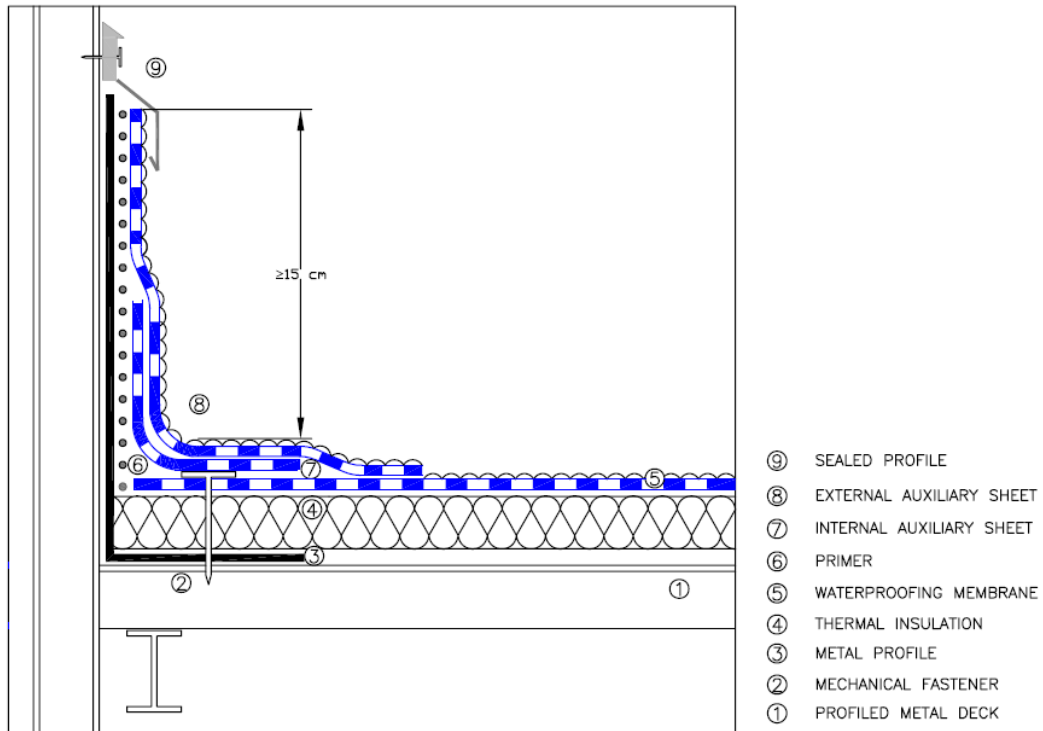


1. STEEL SUPPORT
2. THERMAL INSULATION
3. MAIN WATERPROOF MEMBRANE
4. MECHANICAL FASTENER

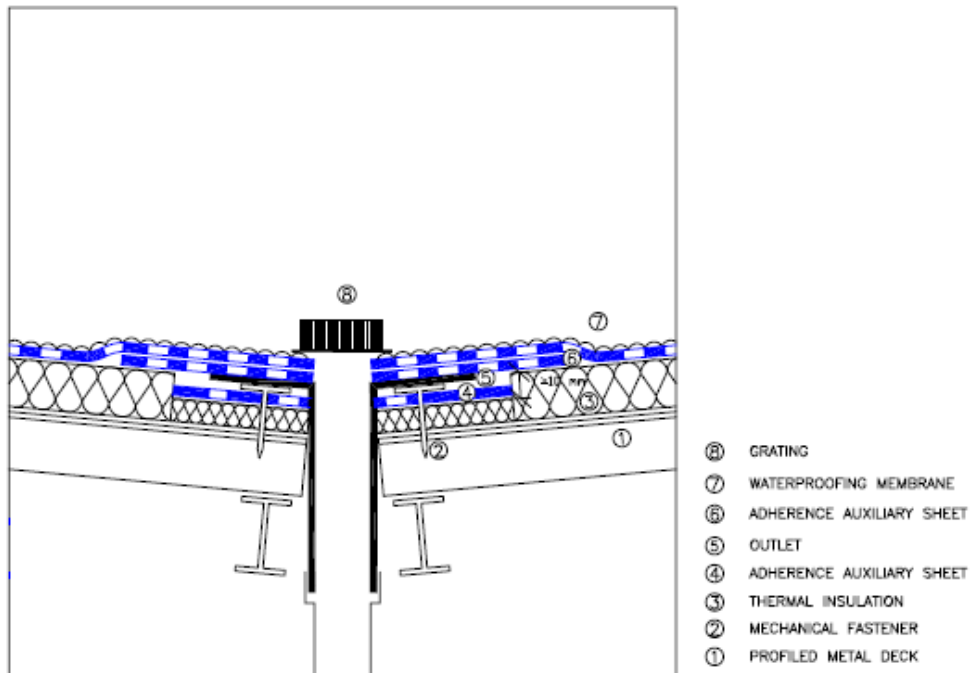
**Fig. 2** Detail of a structural joint



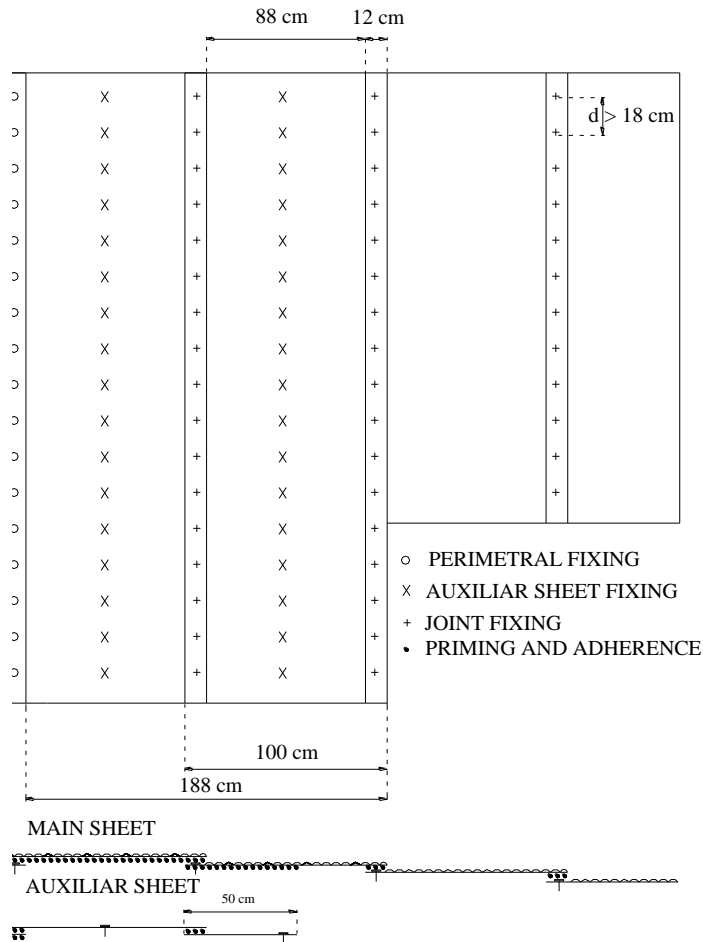
**Fig. 3** Insertion with a vertical wall



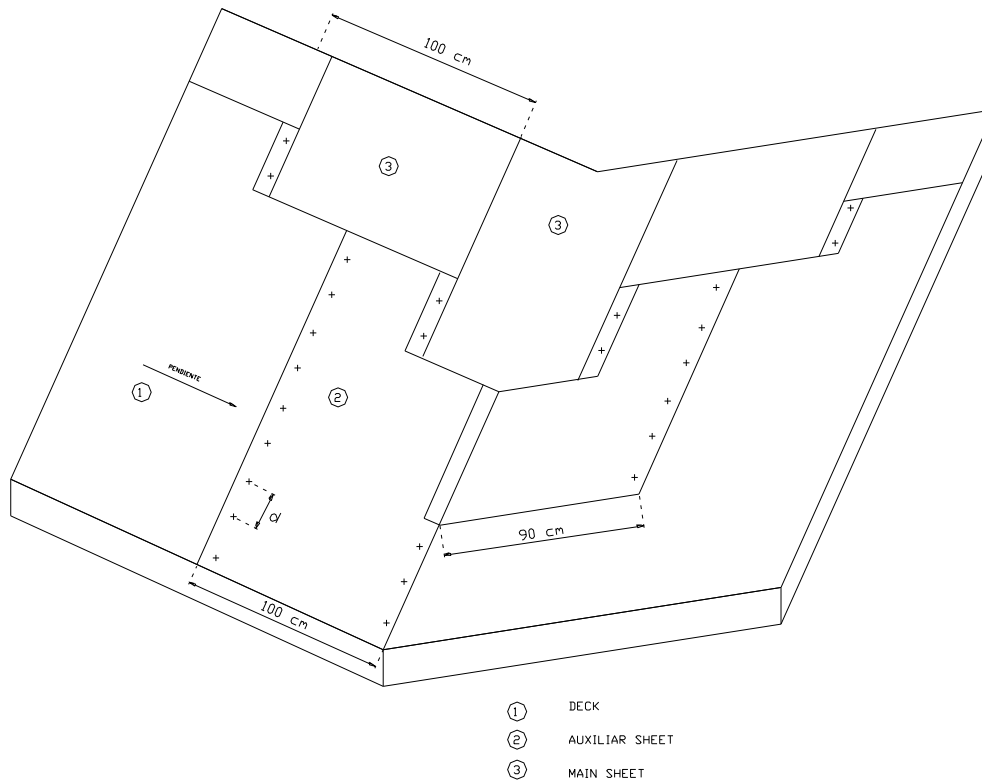
**Fig. 4** Drain detail



**Fig. 5** Corner Detail

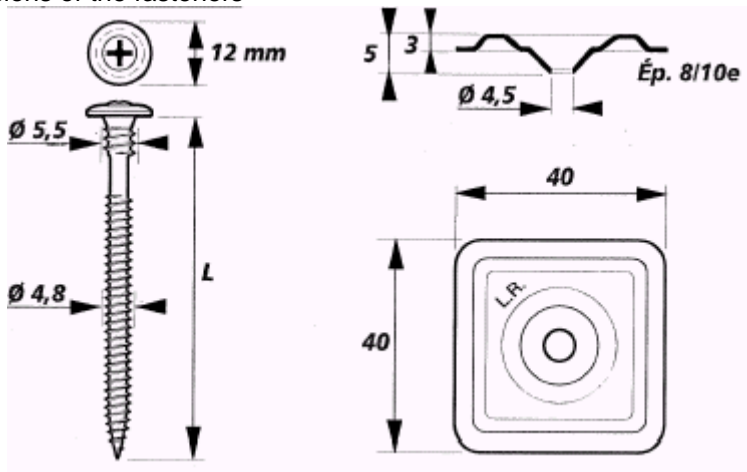


**Fig. 6** Reinforcement membrane on valley gutter



## Annex 1.

### Essential dimensions of the fasteners



The length (L) of the fastener can be 65, 75, 90, 100, 110, 120, 140, 160 and 180 mm.

The fastener is made by Steel with an anticorrosion coat 2C.

The washer is made by steel with aluminium-zinc alloy protection, 8/10e (mm).

## Annex 2

This annex includes a different kind of fasteners, which comply with the requirement of this ETA.

Corrugated steel plates		Axial load (N)	W adm (N / fastener)	ETA number
1	EV DF 2C + 40 x 40	1.640	528	08/0239
2	EV DF 2C + 82x40 R DF	1.740	528	08/0239
3	EVB DF 2C + 40x40	1.380	444	08/0239
4	EVB DF 2C + 82x40 R DF	1.400	450	08/0239
5	ISODRILL TT + 40x40	1.340	431	08/0239
6	ISODRILL TT + 82 x40 R DF	1.340	431	08/0239
7	VMS 2C + 40x40	1.740	528	08/0239
8	VMS 2C + 82x40 R DF	1.660	528	08/0239
9	IR 2 4.8+ IR 82X40 R DF	1.460	470	08/0321

Corrugated steel of punched or bursted surface		Axial load (N)	Wadm (N / fastener)	ETA number
10	FASTOVIS TF 3036 DF 2C + 40x40	1.870	528	08/0239
11	FASTOVIS TF 3036 DF 2C + 82x40 R DF	1.900	528	08/0239

Concrete		Axial load (N)	W adm (N / fastener)	ETA number
12	BETOFAST TH DF 3C + 82X40 R	6.860	528	08/0239
13	TI 6.3 + IRD 82X40	6.270	528	08/ 0262
14	TI 6.3 + IF/IGC 82X40	6.270	528	08/0262

Aerated concrete		Axial load (N)	W adm (N / fastener)	ETA number
15	MULTIFAST TB INOX A2 + 82X40 R	1.540	492	08/0239
16	MULTIFAST TB INOX A2 + 40X40	1.570	505	08/0239
17	IGR-T-T25-8.0+ IG8-C 82 X40	1.600	15	08/0262

Wood and wooden boards		Axial load (N)	W adm (N / fastener)	ETA number
18	MULTIFAST TF + 82X40 R	1.950	528	08/0239
19	EV DF 2C + 82x40 R DF	1.880	528	08/0239
20	IG 6 + IRD 82X40	2.100	528	08/0321
21	IWT 5 + IRC/W 82X40	1.950	528	08/0321

The Wadm determined with the full scale wind uplift with the fastener EV DF 2C + 40 x 40 (Roc) was 528 N/fastener. In order to determine the Wadm of systems with other fasteners (Rnc) on the basis of ETAG 006, it is applied:

If  $R_{nc} \geq R_{oc}$  :  $W_{adm}(nc) = W_{adm}(oc)$

If  $R_{nc} \leq R_{oc}$  :  $W_{adm}(nc) = (R_{nc}/R_{oc}) * W_{adm}(oc)$

### Description of the washers

Washers	Characteristics
40 X 40 mm DF (L.R ETANCO)	Steel plate with aluzinc protection. Thickness 0.8 mm
82 X 40 mm R (L.R ETANCO)	Steel plate with aluzinc protection. Thickness 1 mm
82 X 40 mm DF (L.R ETANCO)	Steel plate with aluzinc protection. Thickness 1 mm
IR 82 x 40 mm (SFS intec)	Steel plate with aluzinc protection. Thickness 0,8 mm
IRP 82 x 40 mm (SFS intec)	Steel plate with aluzinc protection. Thickness 1 mm
IF/IGC 82 x 40 mm (SFS intec)	Steel plate with aluzinc protection. Thickness 1 mm
IG C 82 X 40 mm (SFS intec)	Steel plate with aluzinc protection. Thickness 1 mm
IRD 82 X 40 mm (SFS intec)	Steel plate with aluzinc protection. Thickness 1 mm
IRC/W 82X40 mm (SFS intec)	Steel plate with aluzinc protection. Thickness 1 mm

### Description of the screws

Screws	Characteristics
EVF 2C	Hardened carbon steel screw, with a diameter of 4,8 mm, length L and

(L.R ETANCO)	with a 12 mm circular head. Supracoat corrosion protection. Resistance 15 Kesternich cycles (EN ISO 6988).
EVB DF 2C (L.R ETANCO)	Hardened carbon steel screws with double-thread under head, with a diameter of 4,8 mm, length L and with a 12 mm circular head. Supracoat corrosion protection. Resistance at 15 Kesternich cycles
ISODRILL TT (L.R ETANCO)	Stainless steel screw. Diameter of 4,8 mm, length L and with a 8,5 mm circular trumpet head. A4 (1.4404) Stainless steel.
VMS 2C EG/ZBJ (L.R ETANCO)	Hardened carbon steel screws, with a diameter of 4,8 mm, length L and with a 8,5 mm circular trumpet head. Supracoat corrosion protection. Resistance at 15 Kesternich cycles (EN ISO 6988).
IR 2 4.8 (SFS intec)	Hardened carbon steel screws with double-thread under head, with a diameter of 4.8 mm, length L and with a 8 mm hexagonal flat head. Durocoat corrosion protection. Resistance at 15 Kesternich cycles (EN ISO 6988). Axial Load: 1.450 N*
FASTOVIS TF 3036 DF 2C (L.R ETANCO)	Hardened carbon steel screws with double-thread under head, with a diameter of 6,5 mm, length L and with a 11 mm circular trumpet head. Durocoat corrosion protection. Resistance at 15 Kesternich cycles (EN ISO 6988).
TI 6.3 (SFS intec)	Hardened carbon steel screw. Diameter of 6,3 mm, length L and with a 8 mm hexagonal flat head. Durocoat corrosion protection. Resistance at 15 Kesternich cycles(EN ISO 6988).
BETOFAST TH DF 3C (L.R ETANCO)	Hardened carbon steel screw with double-thread under head, with a diameter of 6,6 mm, length L and with a 8 mm hexagonal flat head. Supracoat corrosion protection. Resistance at 30 Kesternich cycles (EN ISO 6988).
IGR-S 8 (SFS INTEC)	Austenitic stainless steel A2 screw. Diameter of 8 mm, length L with a 12 mm diameter circular trumpet head.
MULTIFAST TB INOX A2 (L.R ETANCO)	Stainless steel screw. Diameter of 6 mm, length L and with a 11 mm circular trumpet head. A2 (1.4301) stainless steel.
MULTIFAST TF (L.R ETANCO)	Stainless steel screw. Diameter of 6 mm, length L and with a 11 mm circular trumpet head. A2 (1.4301) stainless steel.
IG 6 (SFS INTEC)	Hardened carbon steel screw. Diameter of 6 mm, length L and with a 8 mm hexagonal flat head. Durocoat corrosion protection. Resistance at 15 Kesternich cycles(EN ISO 6988).
IWT 5 (SFS INTEC)	Hardened carbon steel screws, with a diameter of 5 mm, length L and with a 9,5 mm circular Trumpet head. Durocoat corrosion protection. Resistance at 15 Kesternich cycles (EN ISO 6988).